

DRAWING REVISIONS			
REV.	DESCRIPTION	DATE	APRVL

DRAWING APPROVAL:

SIGN: _____

DATE: _____

PIPE LEGS AND FEET NOT INCLUDED, SOLD SEPARATELY
THREADED RUBBER SEALED CAPS INCLUDED

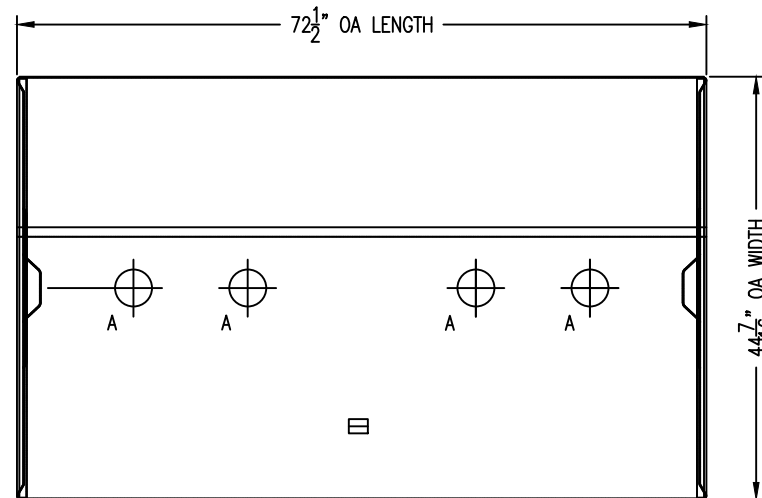

TOP VIEW

FLANGE OPENING LEGEND	
A	2" NPT FLANGE
B	1/2" NPT FLANGE
C	-
D	-
E	-
F	-

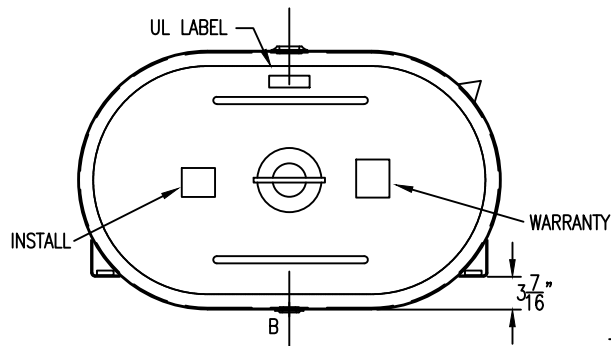

SIDE VIEW

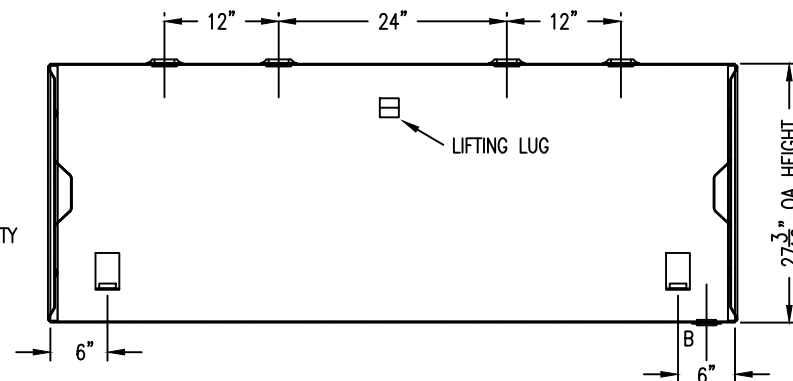

FRONT VIEW

PRELIMINARY DRAWING ONLY

ALL RIGHTS RESERVED. THIS DRAWING OR ANY PART THEREOF MUST NOT BE REPRODUCED IN ANY FORM UNLESS GIVEN PERMISSION BY A REPRESENTATIVE OF THIS COMPANY

806 Island Ford Road
 McGaheysville, VA 22840

Phone 800-522-4980
 540-289-5051
 FAX 540-289-7592



ATLANTIC
CONTAINMENT

DESCRIPTION: 330 OBROUND SW HORIZ HEATING OIL LUG STYLE

CUST: ATLANTIC CONTAINMENT
MATL: CARBON STEEL, 12 GA
WELD: MIG (EXTERNAL ONLY)
TYPE: UL 142 LISTED
CAPACITY: 330 GALLONS
WEIGHT: 320 LBS
EXT. FINISH: BLACK OR GRAY URETHANE

DATE: 02/05/21	DWG BY: NM
DWG NO. AC330HHO	REV. NO. -